

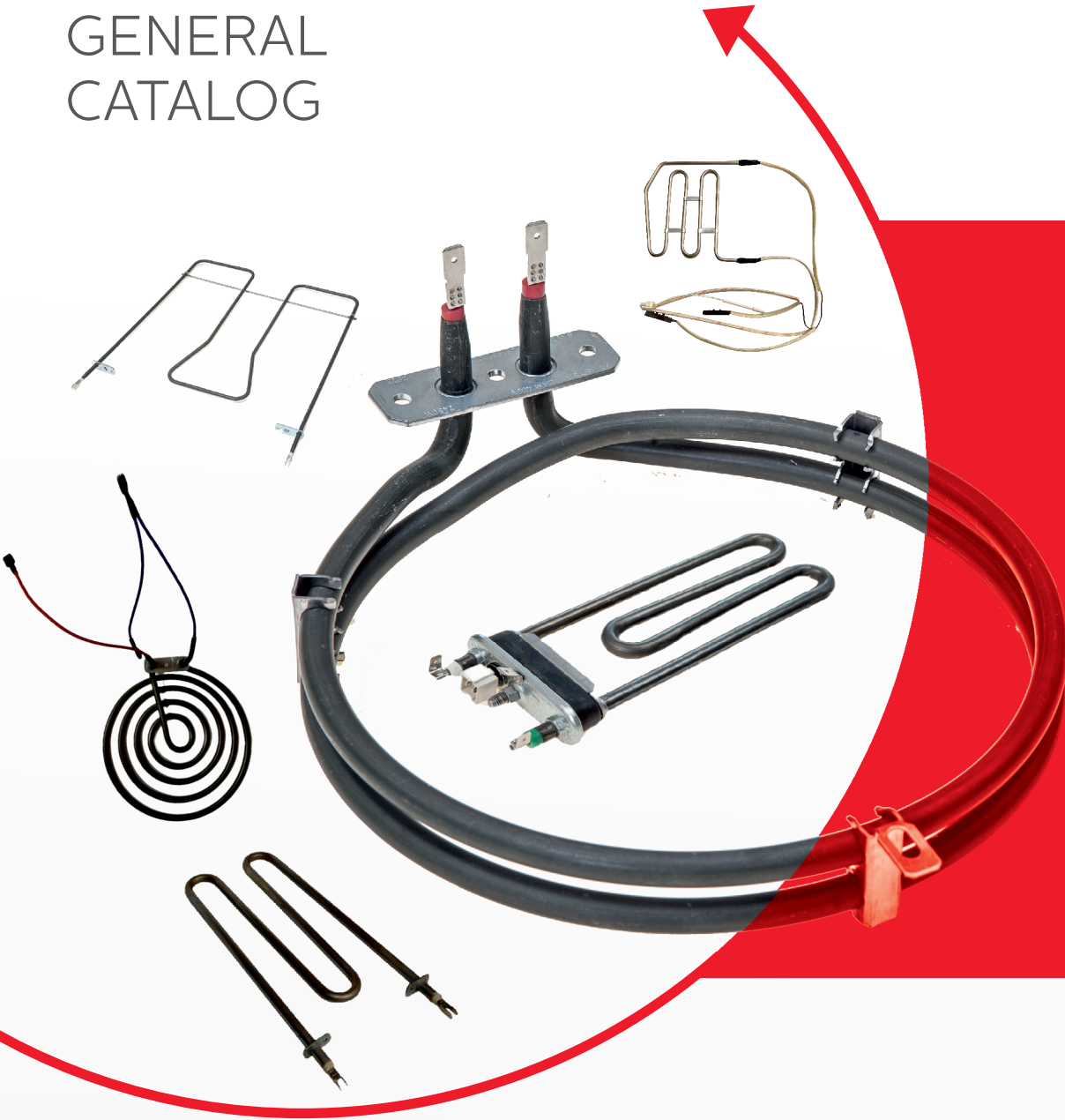

şahterm[®]
heating elements

**GENEL
KATALOG
GENERAL
CATALOG**



VİZYONUMUZ / OUR VISION

Ürün, hizmet ve iletişimde yüksek kaliteyi doğal süreç olarak görerek, bu yüksek standartları ek bir bedel ödemededen müşteriye sunmak,

İhtiyaçların sınırsız, kaynakların sınırlı olduğu bilinciyle; çevreye ve insan haklarına saygılı bir kurum kimliğini ilelebet sürdürmek,

Gelecek 10 yıl içerisinde, rezistans sektörüne verimlilik, yüksek kalite ve rekabetçilik anlamında dünya lideri olmak.

To see high quality in products, services and communication as a natural process and to offer these high standards to the customer without paying any additional cost.

To maintain the identity of an institution that respects the environment and human rights, with the awareness that needs are unlimited and resources are limited

To be the world leader in the Heating Elements sector in terms of efficiency, high quality and competitiveness within the next 10 years.

MİSYONUMUZ / OUR MISSION

Verimliliğimiz ile ülke ekonomisine katkı sağlayan, tüm kaynaklarını etkili bir şekilde kullanarak çalışanlarına, topluma ve çevreye katkıda bulunan bir dünya şirketi olmak.

Müşterilerimizin artan ve çeşitlenen taleplerine karşılık, yenilikçi yaklaşımlarla, hızlı çözüm üretmek ve talep değişimlerinde müşteriye uygun esneklik sağlayarak fark yaratmak.

Sürekli iyileştirme yaklaşımı ile sorunları önlemek ve en ideal çözümlere ulaşmak için müşterilerimiz ile ortak tasarım ve geliştirme projeleri yürütmek

With our effectiveness, productivity, to be a global compant that contributes to the country economy, increasing continually and distinctly the value we contributed to our employees, society and environment by using effectively all the resources we posses.

To generate quick solutions through innovative approaches and create a difference by providing appropriate flexibility to our customers to meet their changing and diversifying needs.

Carrying out joint design and development projects with our customers to prevent problems and reach the most ideal solutions with a continuous improvement approach.



STRATEJİMİZ VE İLKELERİMİZ / OUR STRATEGY AND POLICIES

Teknolojide yaşanan gelişimleri hızlı ve etkin bir şekilde izlemek, ısıtıcı performansını arttıran güvenilir ürünlere dönüştürmek.

Çalışanlarımıza, yaratıcılıklarını üretkenliğe dönüştürebilecekleri ve geleceğe güvenle bakabilecekleri bir çalışma ortamını hazırlamak.

Yüksek kalitede ve güvenilir ürün ve hizmet sunmak için, ürün mükemmelliğimizi ve yenilikçi teknoloji yaklaşımımız sürdürmek.

Etkin Ar-Ge ve Ür-Ge çalışmalarımızı kararlıkla sürdürerek inovasyon yaratacak sonuçlar elde etmek.

To monitor technological developments quickly and effectively and to transform them into reliable products that increase heater performance.

To create a working environment for our employees where they can transform their creativity into productivity and look to the future with confidence.

To provide high quality and reliable products and services, we maintain our product excellence and innovative technology approach.

To achieve innovative results by continuing our effective R&D and P&D studies with determination.



Oven

Heating Elements



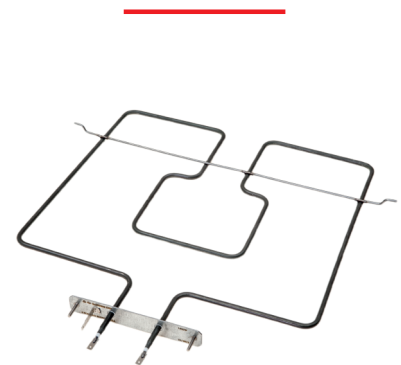
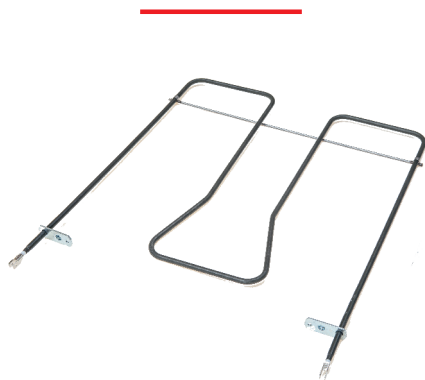
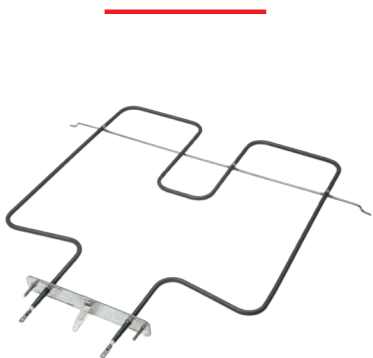
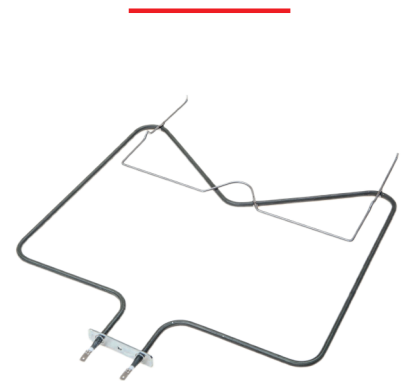
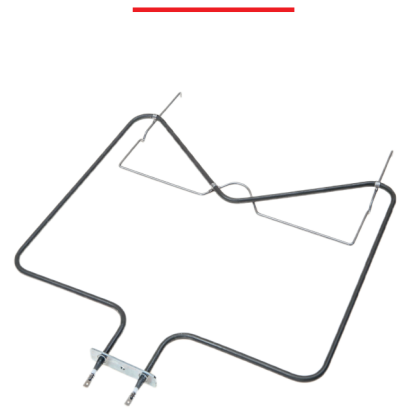
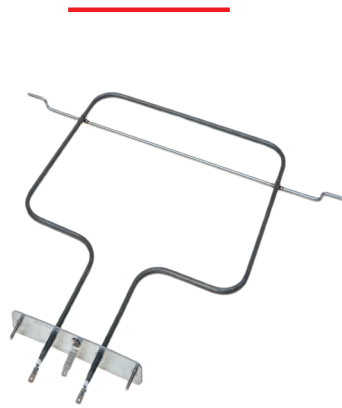
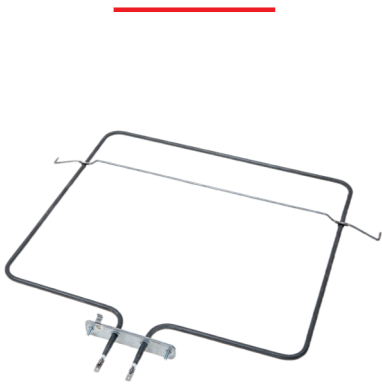

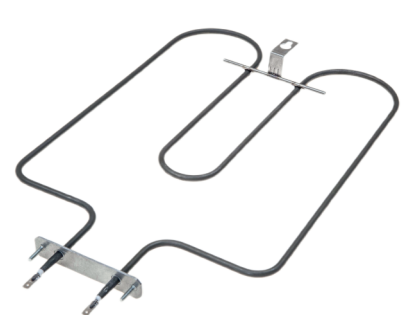
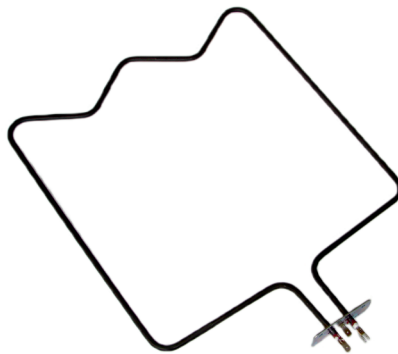
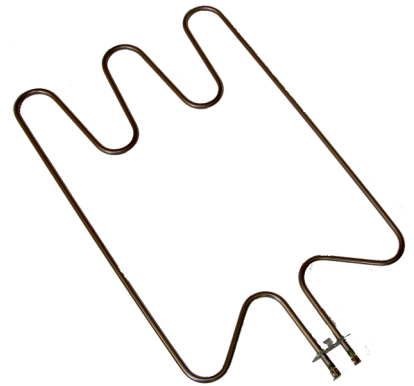
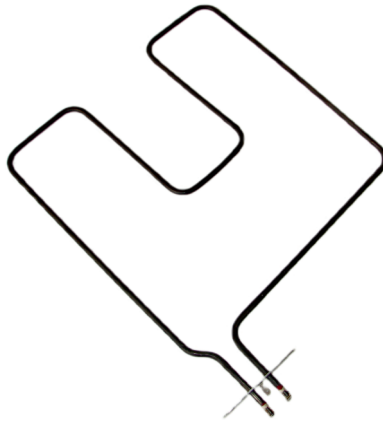
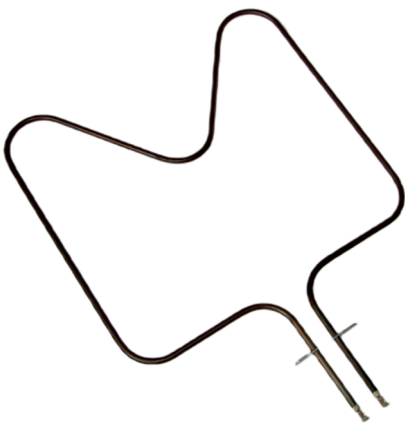
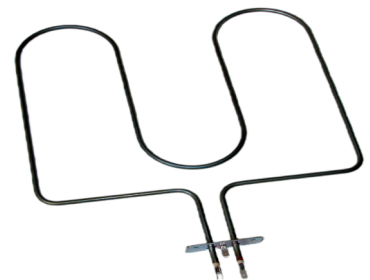
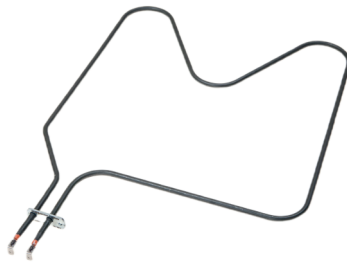
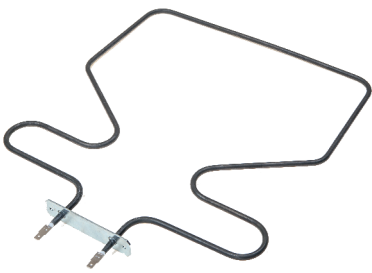

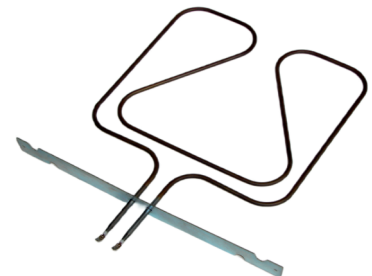
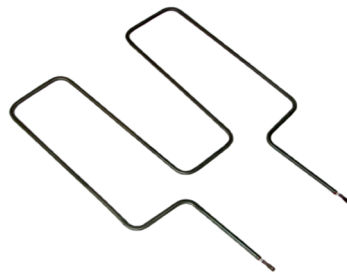
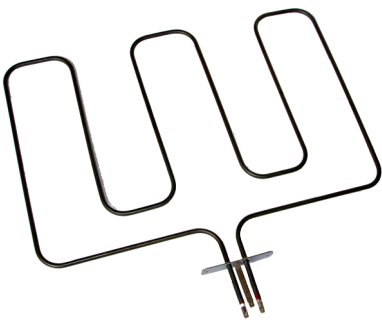
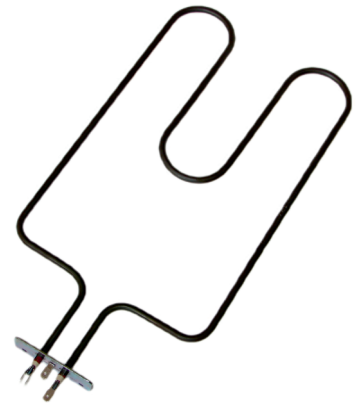
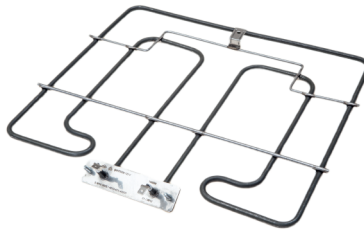
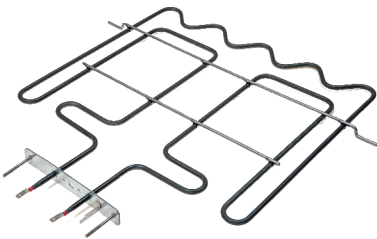
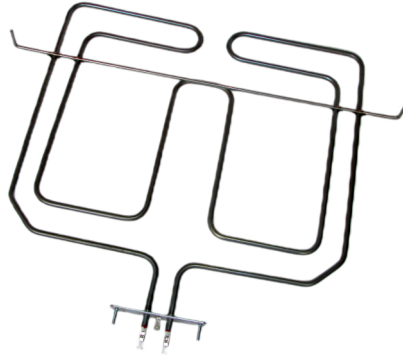
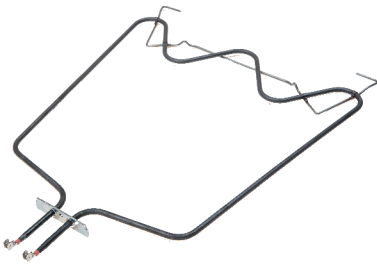

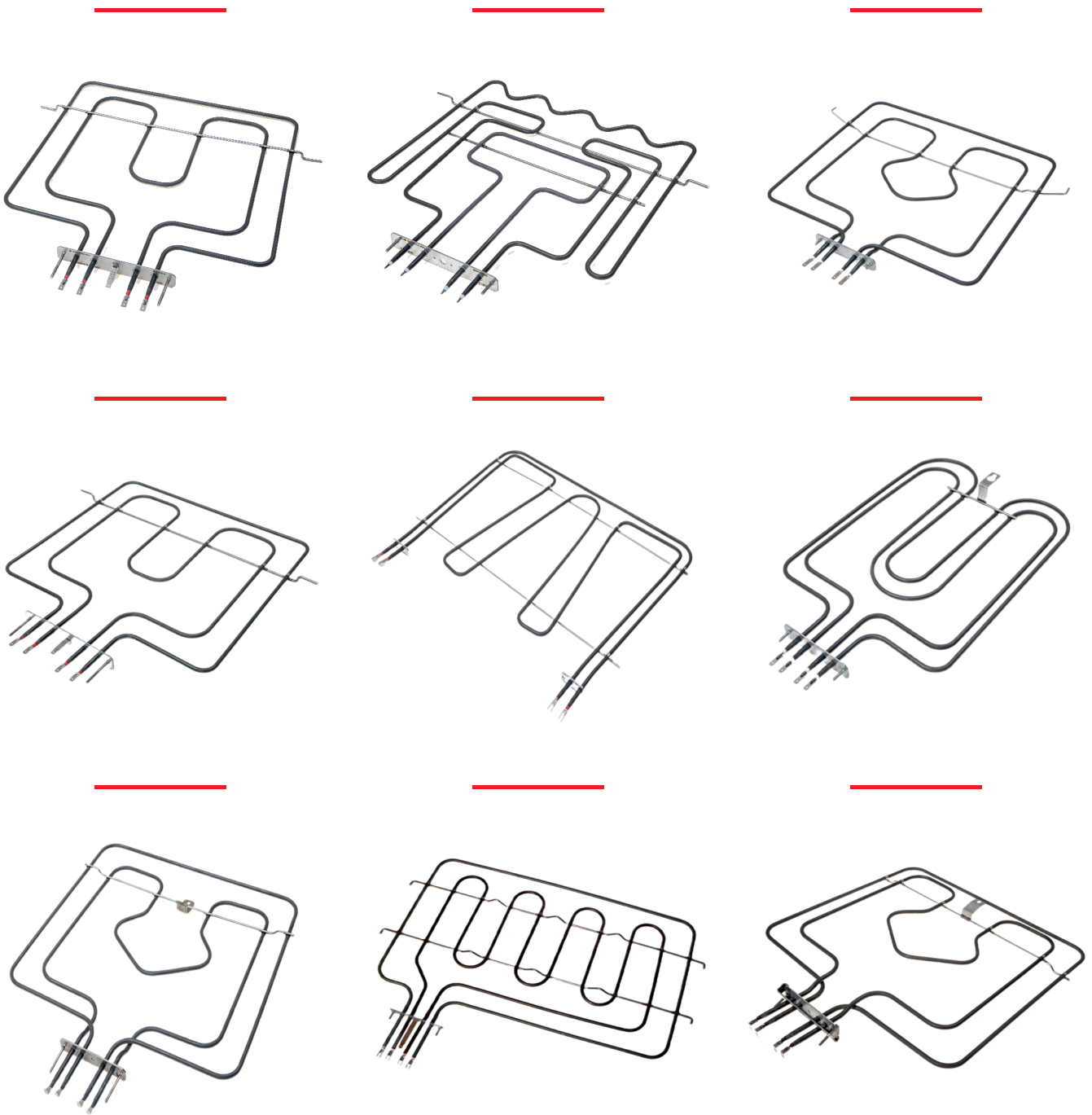

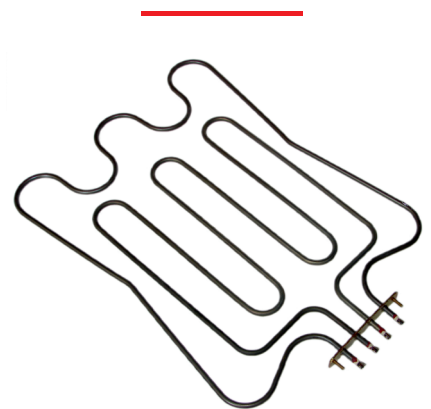
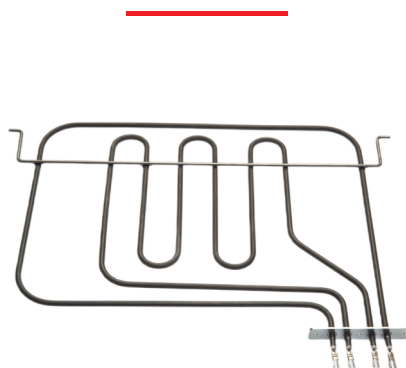
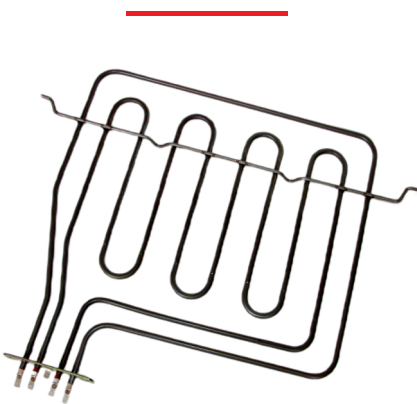
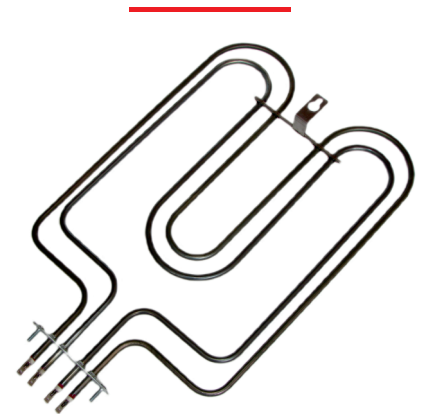
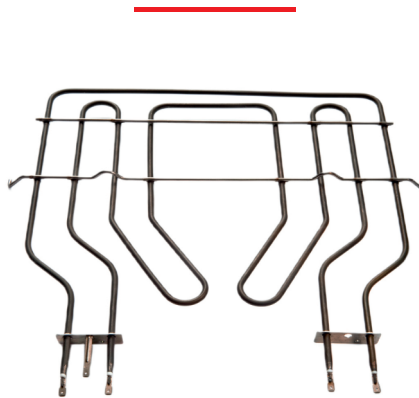
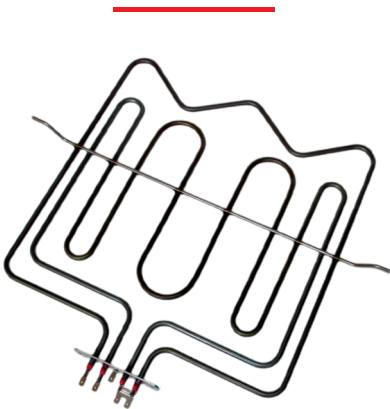
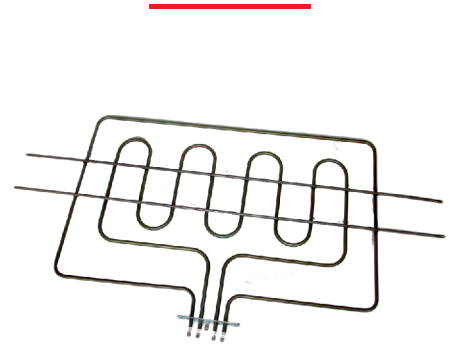
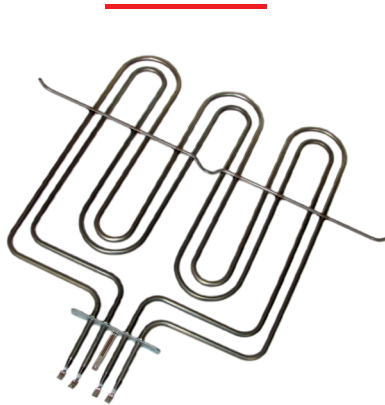



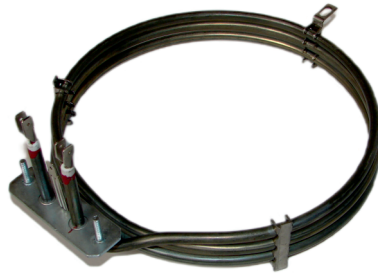



Industrial Kitchen Heating Elements

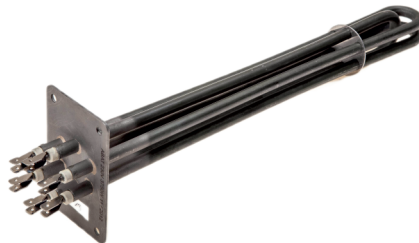

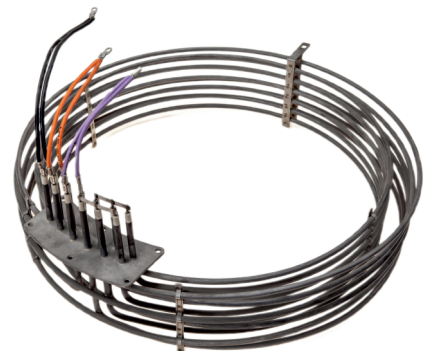

Washing Machine Heating Elements





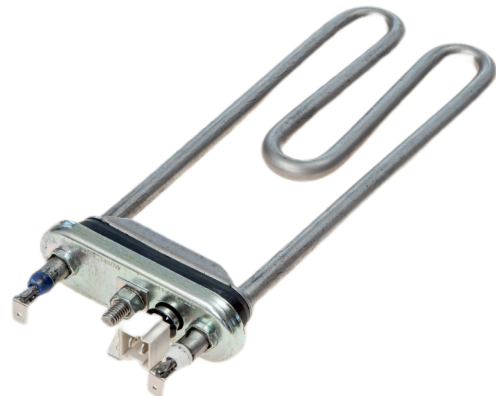
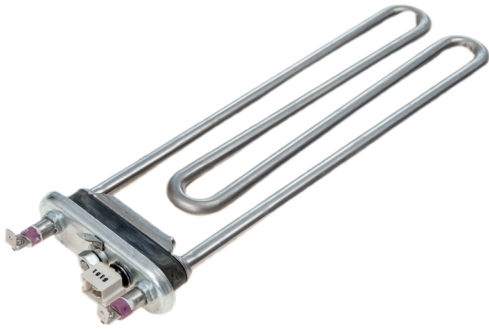

Refrigerator

Heating Elements



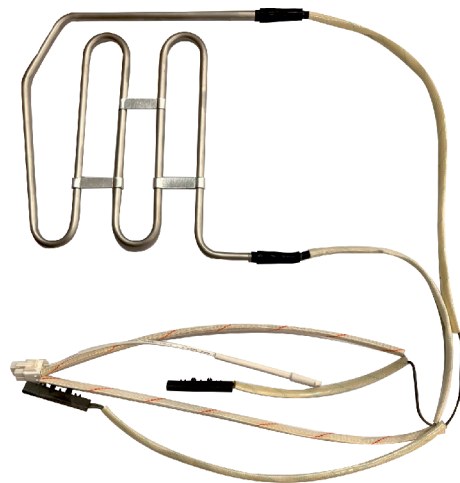
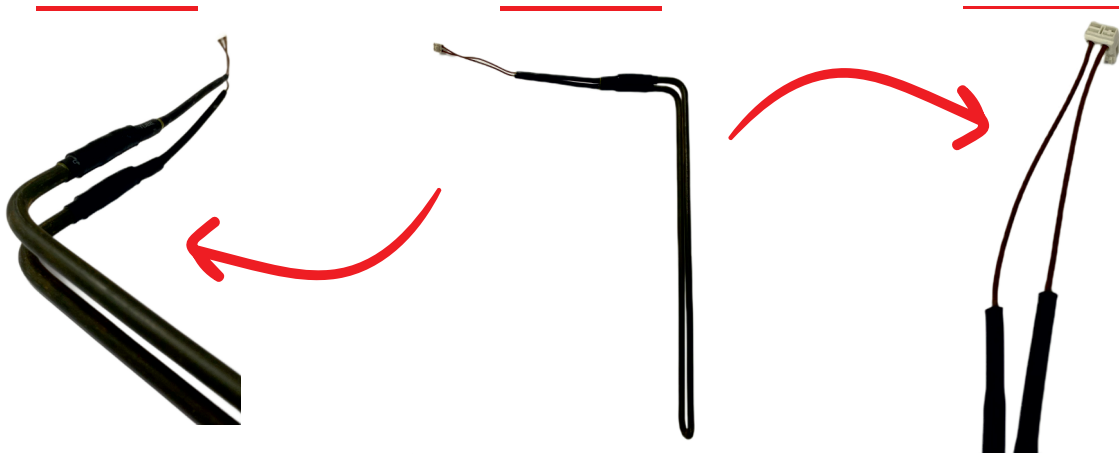

**Small Home
Appliances**
Toast&Raclette
Barbecue&Airfryer



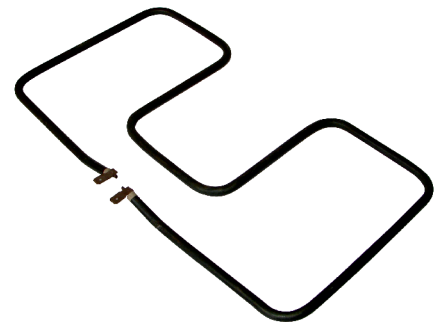
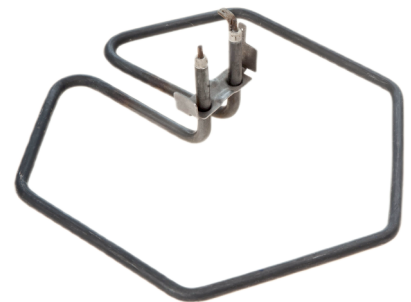
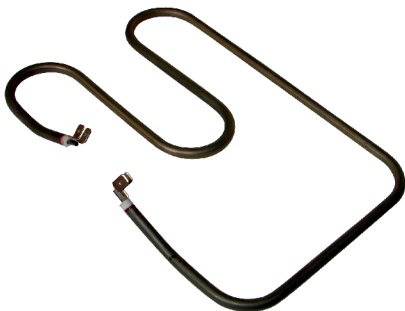
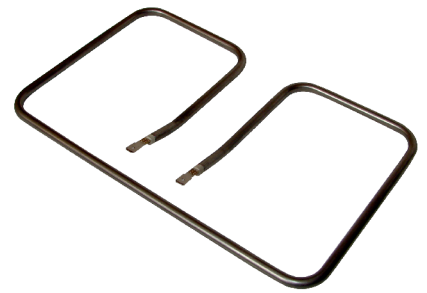
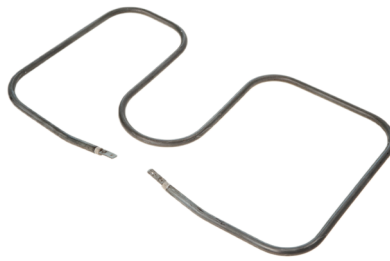

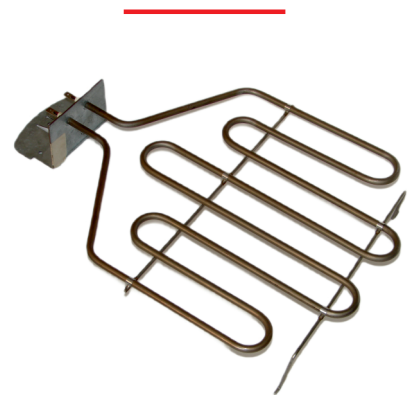
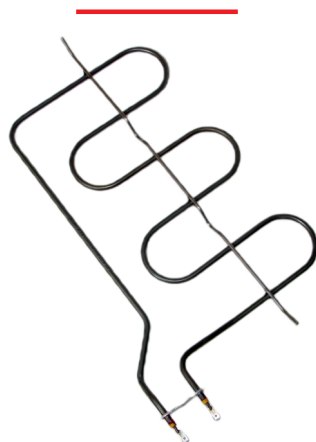
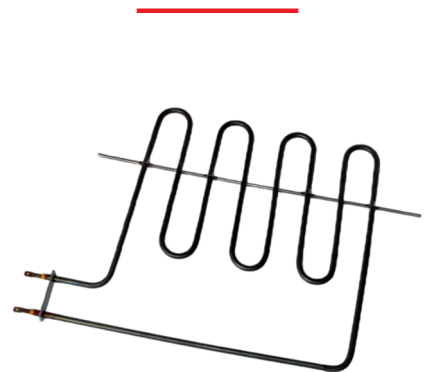
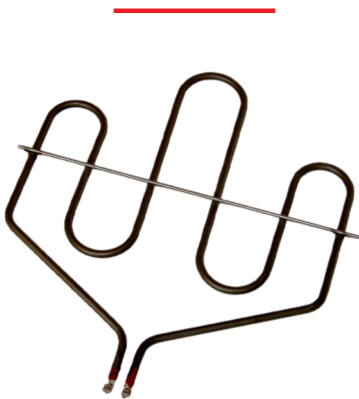

Dishwasher

Heating Elements



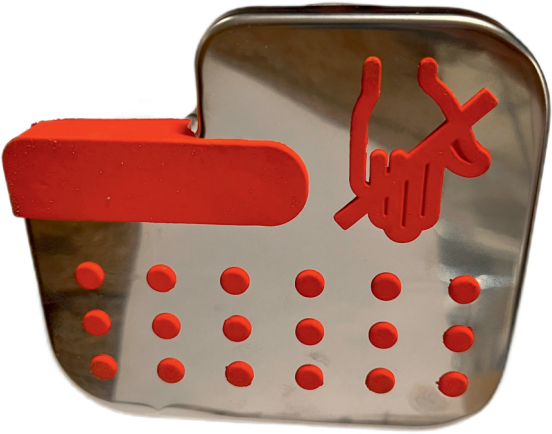

Bulaşık Makinesi Kurutucu Rezistans - Dishwasher Dryer Heating Elements



Kalite Ve Tasarımın Sonsuz Yolculuğunda Daima En Önde

Always Front Runner In The Endless Journey Of Design & Quality





ŞAHTERM ELEKTRİKLİ ISITICILAR SAN. ve TİC. A.Ş.
Hasanağa OSB Mh. HOSAB San. Cd. No:55 NİLÜFER/BURSA

 **0 224 261 17 40**
 **www.sahterm.com**